

ALUMINIUM BIFOLD DOOR

Installation Guide



FOLDING SLIDING DOOR – INSTALLATION

OPTION A: FITTING FRAME WITH DOOR LEAFS IN POSITION

When using this method it is extremely important to ensure that there is no movement of the door leaves, otherwise there is a risk that the door set may slide open and cause significant damage.

1. A silicone sealant should be applied to the structure opening across the entire width of the door to allow the cill to sit on.

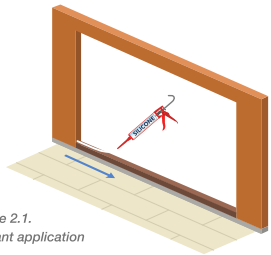

Figure 2.1.
Sealant application

2. Place the cill into the aperture and pack at each fixing point to ensure the cill is level across the entire width of the aperture. Once level it must be fixed to the structure using the method highlighted from the survey.

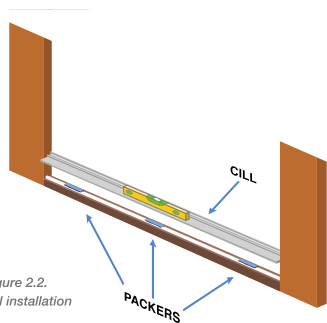

Figure 2.2.
Cill installation

3. Place a continuous bead of silicone on to the cill and place the outer frame into position. Ensure the door leaves are in the fully opened position and supported to prevent them over balancing.

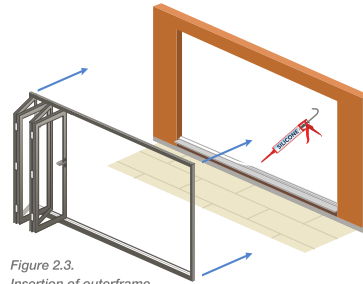

Figure 2.3.
Insertion of outerframe

4. Ensure that the head, cill and jambs are all square. Then temporarily secure the outerframe to the structure and pack where necessary.

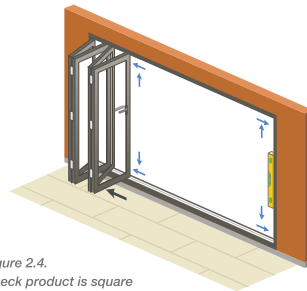

Figure 2.4.
Check product is square

5. Once square and level, secure into the aperture. The fixing locations need to be 150mm from the external corners and thereafter no greater than 600mm centres.

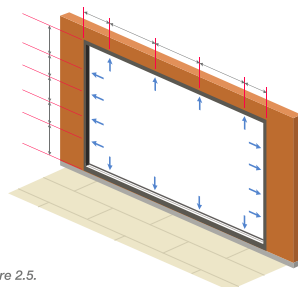

Figure 2.5.
Fixing locations (doors removed)

OPTION B: FITTING FRAME WITHOUT DOOR LEAFS IN POSITION

1. Remove machine screws on the hinges to release the door leaf (See Figure 2.6).

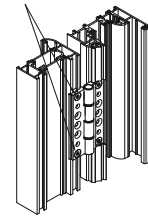

Figure 2.6.
Door leaf removal

2. Carefully remove the door leaf and place in a safe location. This may require more than one person. Use an identification method to label the door leaves to ensure that they are re-fitted in the correct position.
3. Take great care to ensure that the hinge packers located behind the hinge are not misplaced.
4. Now the door leaves have been removed, insert the outer frame into the brickwork aperture.
5. A silicone sealant should be applied to the structure opening across the entire width of the door to allow the cill to sit on.

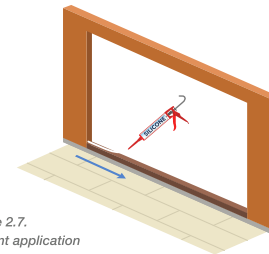

Figure 2.7.
Sealant application

6. Place the cill into the aperture and pack at each fixing point to ensure the cill is level across the entire width of the aperture. Once level it must be fixed to the structure using the method highlighted from the survey.

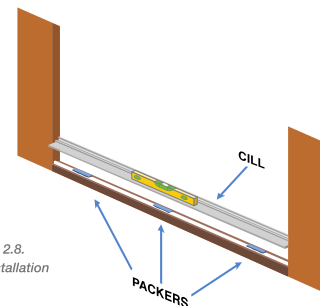

Figure 2.8.
Cill installation

7. Place a continuous bead of silicone to the cill and insert the outer frame into position.

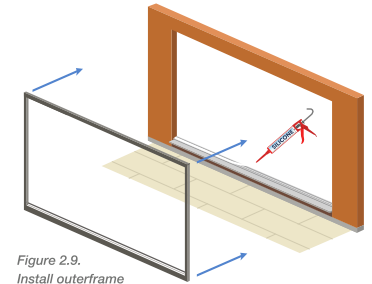

Figure 2.9.
Install outerframe

8. Ensure that the head, cill and jambs are all square.

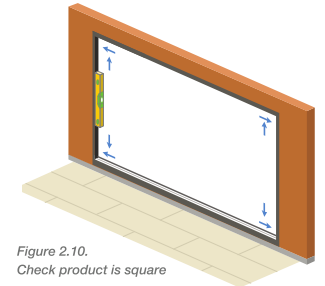

Figure 2.10.
Check product is square

9. Once square and level, secure into the aperture. The fixing locations need to be 150mm from the external corners and thereafter no greater than 600mm centres.

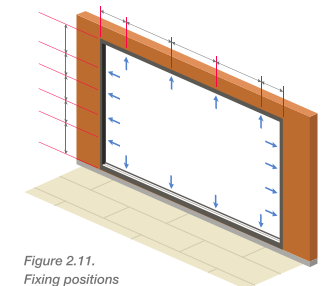

Figure 2.11.
Fixing positions

Once the outerframe is fully secured, take care replacing the removed door sashes to ensure that they are in the exact position that they were removed from.

INSTALLATION

FIXING

Once you have checked that the doors are level and correctly located within the aperture, fix the door to the structure using the method highlighted from the survey.

Two fixing methods can be used:

1. Direct Fixing
2. Fixing Lugs (straps)

For details on which fixing lugs are used with which frames, please refer to the relevant technical manuals. Fixings used will depend on the structure to which the doors are being fixed.

The following information applies to both fixing methods.

All fixings should be:

- Made of a suitable material to resist corrosion – i.e. stainless steel.
- Silicone dipped to ensure water cannot penetrate the fixing hole.

During fixing:

- Use packing local to fixings to ensure frame is not deformed when fixings are tightened (see figures 3.1. and 3.2.).
- If framework still appears to be deformed, check that the fixings have not been overtightened.
- Position the fixings so that they do not hinder the operation of any gearing.
- Countersink direct fixing screws to prevent obstruction of the operation of any gearing.

Fixing locations need to be:

- 150mm from external corners.
- Spaced at a minimum of 600mm centres.

Figure 3.1. Outward opening fixing details

Direct fixing

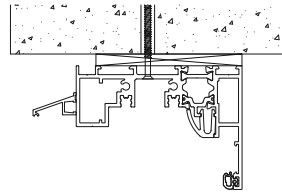

Cill fixing

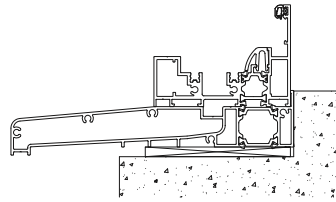
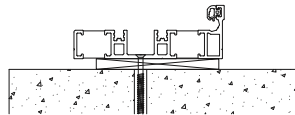

Figure 3.2. Alternative outward opening low threshold fixing details

Direct fixing



Cill fixing

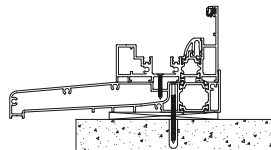
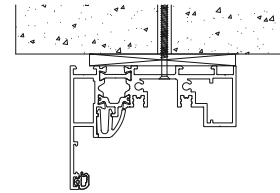

Figure 3.3. Inward Opening Fixing Details

Direct Fixing Head



Cill Fixing

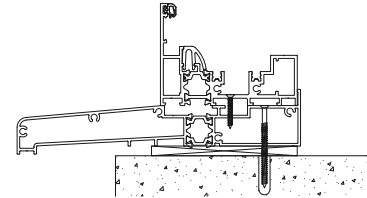
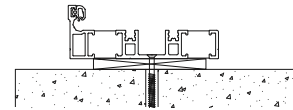

Figure 3.4. Alternative Inward Opening Low Threshold Fixing Details

Direct Fixing



Cill Fixing

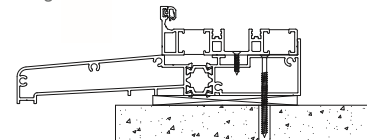
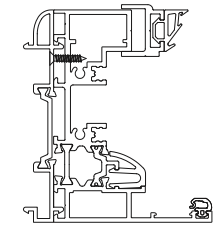
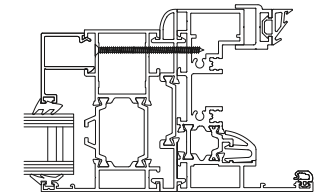

Figure 3.5. Coupler Fixing Details

Fixing Through Coupler to Frame



Fixing Frame to Frame Through Coupler



1. Remove beads from one door sash at a time, taking note of the location they are removed from to ensure they are replaced into their original positions.
2. Push in SP2396 glazing gasket. The gasket should be continued with the joint and should be at the centre of the top rail. Insert the corners first and ensure at least 1% - 2% over length.
3. Fit PURGS04 glass supports as shown in Figure 4.1 for positioning and locations. When establishing the correct depth of the glazing location packer, make sure there is a minimum 1mm clearance. To meet PAS24:2012, all locations must be packed as shown in the Packing Details section.
4. Place the glass unit into the door and silicone seal along the bottom of the glazed unit and 150mm up both sides. Ensure that the silicone used is compatible with butyl on the glazed units as shown.
5. Locate horizontal internal glazing beads first, followed by the vertical internal glazing beads.
6. Insert SP2400 (28mm Glazing) internal wedge gasket to secure, the gasket should be continuous with the joint. The joint should be the centre of the top rail. Insert the corners first and ensure at least 1% - 2% over length. Repeat process until all sashes are glazed. **Ensure that all sashes are 'toe and heeled' as per guidelines on pages 13 and 14.**
7. Check that the sashes are level by taking measurements from the top frame section as shown in figure 4.3. Repeat this for all sashes.

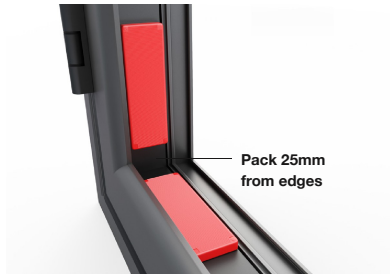

Figure 4.1. Pack 25mm from edges.

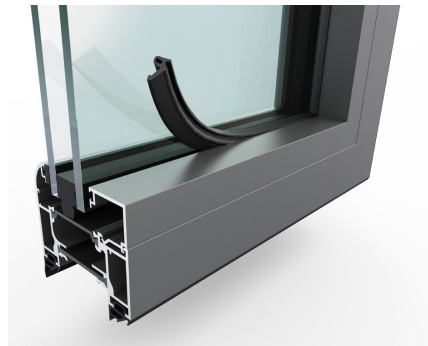

Figure 4.2. Insertion of gasket wedge.

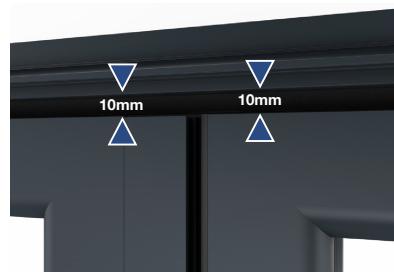
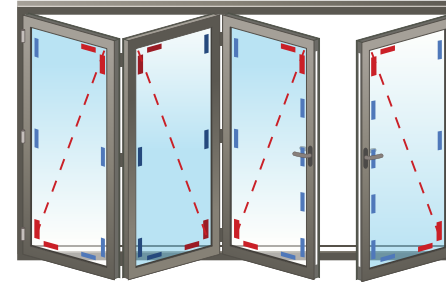
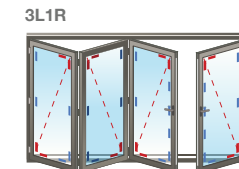
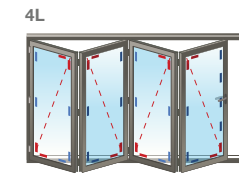
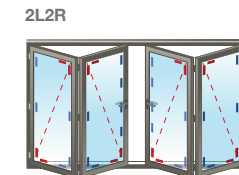
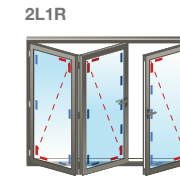
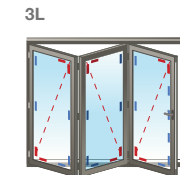
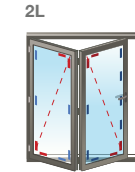

Figure 4.3. All Sashes should be level.

PACKING DETAILS



KEY
Red = weight bearing packing positions
Blue = Other packing positions



5L

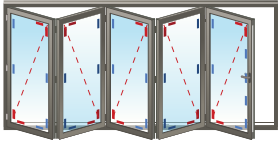

4L1R

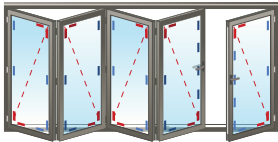

6L

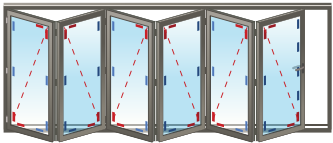

4L2R

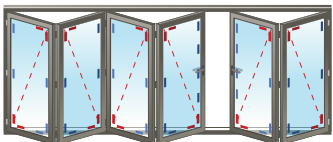

7L

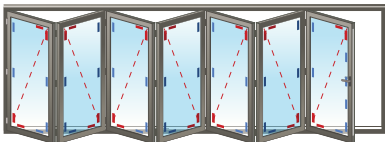

5L2R

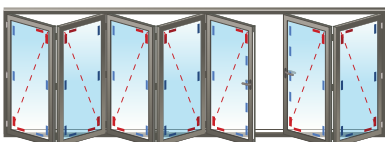

3L2R

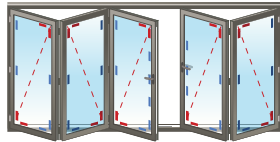

5L1R

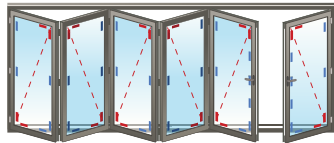

3L3R

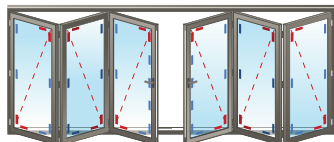

6L1R

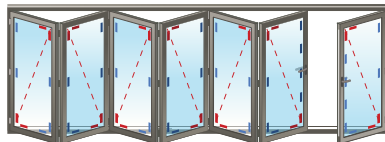

5L3R

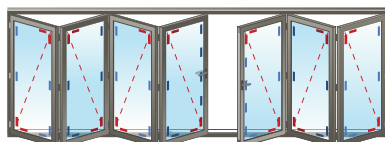

ADJUSTMENTS

If the door set doesn't operate as required, you may need to make an adjustment.

There are three adjustments which can be carried out on the PURe® FOLD and Ali FOLD.

1. If the door requires any lateral adjustment, this can be done by simply slackening the 3No. SFSCM0425 machine screws as shown in 'Figure 5.1' labelled as 'A'. Once slackened, add or remove PURPK1 Hinge Packs as required. Once the adjustment has been completed, ensure that the 3No. SFSCM0425 machine screws are secured. Depending on the door configuration, a further adjustment can be made on the opposite jamb by repeating the above process.
3. If the door needs to be adjusted to ensure the correct compression against the outer frame, a -2mm/+1mm adjustment can be achieved by relocating the PURD03SBK Shootbolt keep. See Figure 5.3.

Figure 5.3

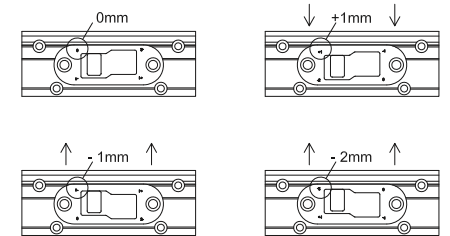
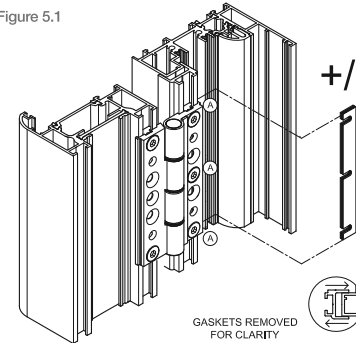

Figure 5.1



2. To ensure that the door leaf has the correct compression against the outer frame, the PURSBEG end guides can be laterally adjusted $\pm 1.5\text{mm}$ as shown in fig 5.2. Loosen the SFSPS28 screws slightly and move the end guide as required. Once adjusted, tighten the SFSPS28 screws.
4. A 1mm reduction can be achieved on the hinges by removing the hinge adjustment strips. Unfasten the 2No machine screws labelled 'B', open the hinge and remove the 2No. 0.5mm Adjustment Strips as shown in Figure 5.4. When removed, move the hinge back into position and secure the machine screws. Ensure adjustments are carried out on only one side of the hinge at a time. Repeat the process for the opposite side of the hinge, and then on all the other hinges on the door leaf to achieve the 1mm reduction.

Figure 5.2

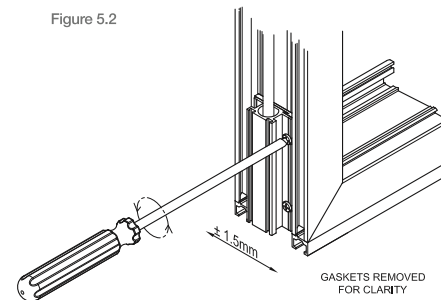
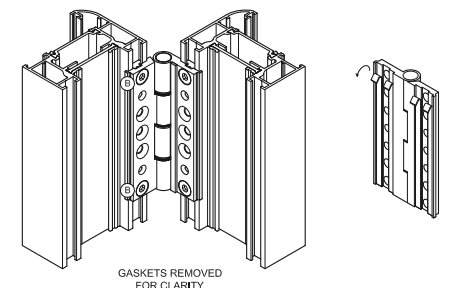

Figure 5.4



FINAL FIXINGS

Once all the doors are correctly aligned and fully glazed, secure the hinges with final hinge fixings. Please refer to the relevant hinge detail as shown below (Figure 9, 10 & 11). It is recommended that you view this in conjunction with the relevant technical manual.

Detail 'D' As Shown.
Detail 'D1' Opposite Hand .

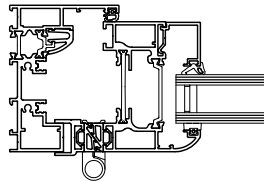

THE HINGES NEED TO BE SECURED AS THE FOLLOWING:-
LOCATION **A** SECURE WITH SFSCS30 SCREWS
LOCATION **B** SECURE WITH SFSCM0425 MACHINE SCREWS

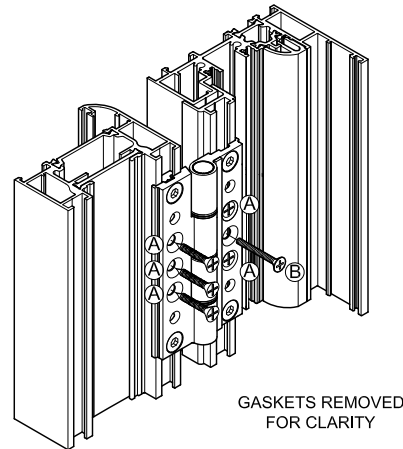

Detail 'E' As Shown.
Detail 'E1' Opposite Hand .

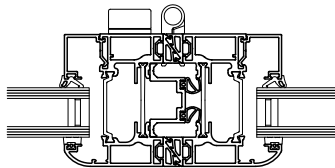

THE HINGES NEED TO BE SECURED WITH 3No. SFSCS30 SCREWS TO EACH HINGE LEAF.

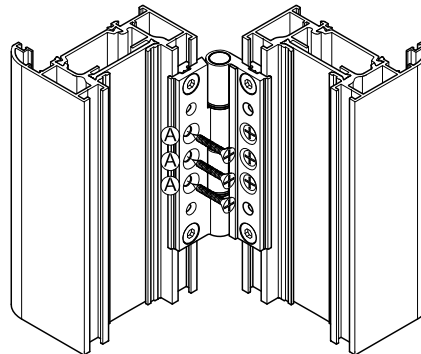

Detail 'F' As Shown.
Detail 'F1' Opposite Hand .

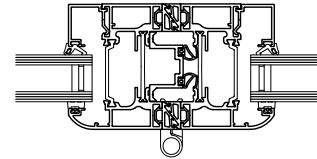

THE HINGES NEED TO BE SECURED WITH 3No. SFSCS30 SCREWS TO EACH HINGE LEAF.

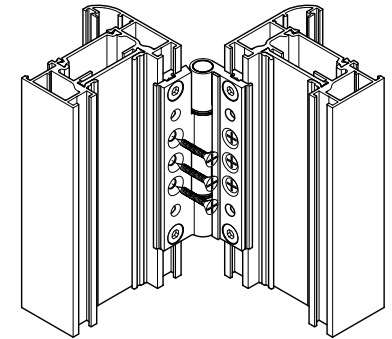

CHECKING

OPERATION

When all frames are fixed and glazing is installed, check the operation of the doors.

It is good practice to:

1. Ensure that all door gearing is not too tight/loose when locking the door.
2. Check gaskets to ensure there isn't any catching.

Please refer to the relevant technical manuals and/or this guide if any adjustments need to be made.

End User Guidance manuals for PRe® FOLD and Ali FOLD systems can be obtained from the Senior Architectural Systems Ltd website.

GENERAL CHECKS

General checks should be carried out to ensure:

- Drainage is adequate and is not blocked (see technical manual).
- All mitres are still tight and sufficiently sealed. If mitres have opened on the outerframe, this could be because the fixings are either too tight or too close to the mitres. An open mitre on the door sash could indicate that the glass has been incorrectly toe-and-heeled.
- Operation of all doors (handles and hinges) is as required.
- All beads are fitted correctly and square.
- All faces are free from damage and debris and that protective tape is removed from frames.
- Compression of gaskets is correct when window is in locked position.
- Cill end caps are fitted and sealed (if required).

PERIMETER SEALING

To create a weather proof seal at the perimeter of the doors, you will need to apply a sealant between the externally facing door frame and the structure.

Use an appropriate sealant to suit:

- The framing surface/finish/material
- The structure surface/finish/material
- Joint size
- Anticipated movement of frames and structure
- Anticipated exposure to weather

Apply the sealant to a clean dry surface as outlined within the sealant manufacturer's guidelines and where possible against a backer rod or similar.

Make sure that the protective tape on the framing is peeled back so that the sealant is applied to the framing and not the tape.

Any DPM's used on the door must be sealed sufficiently to both the frame and structure in the correct locations. This should be agreed with the contractor & client prior to fitting.

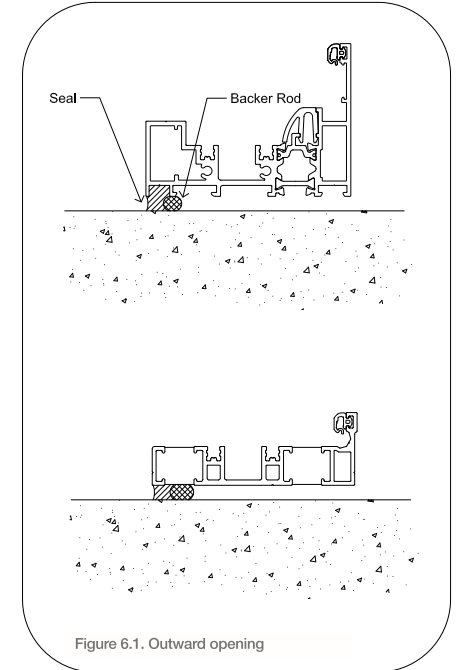

Figure 6.1. Outward opening

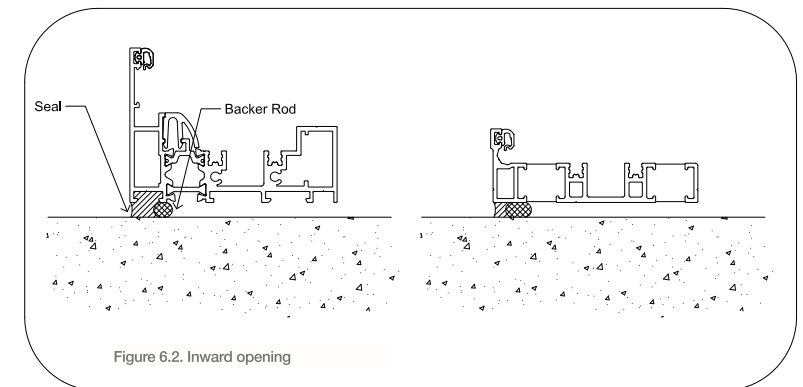

Figure 6.2. Inward opening